



[www.draminski.com](http://www.draminski.com)



# *DRAMINSKI TG pro coffee*

Smart moisture meter with sample compression for coffee beans and cocoa

MANUAL

EN

ISO 9001 | CE

# TABLE OF CONTENTS

	INTRODUCTION . . . . .	3
SECTION 1	EQUIPMENT . . . . .	5
SECTION 2	DESIGN OF THE DEVICE . . . . .	7
SECTION 3	KEYBOARD FUNCTIONS . . . . .	11
SECTION 4	STARTING THE DEVICE . . . . .	13
SECTION 5	NOTES TO THE MEASUREMENT . . . . .	17
SECTION 6	HUMIDITY MEASUREMENTS . . . . .	21
SECTION 7	MEASUREMENTS WITH AN EXTERNAL TEMPERATURE PROBE . . . . .	25
SECTION 8	LIST OF AVAILABLE SPECIES AND ADDING NEW SPECIES. . . . .	29
SECTION 9	UPDATE VIA USB . . . . .	31
SECTION 10	MODIFICATION OF HUMIDITY RESULTS. . . . .	33
SECTION 11	MAIN MENU . . . . .	37
SECTION 12	BATTERY REPLACEMENT . . . . .	49
SECTION 13	FINAL REMARKS . . . . .	53
SECTION 14	TECHNICAL DATA . . . . .	55



# INTRODUCTION

Thank you for purchasing Dramiński TG pro coffee - a new coffee and cocoa moisture meter. This perfect device will be an irreplaceable tool in your business. Thanks to the special design of the device (and compression of the sample before measurement) moisture content will be precisely determined.

Innovative solutions, advanced technology, USB connection and the possibility to connect an external temperature probe turn the purchase of TG pro coffee into a priceless investment. We wish you a pleasant work with the intelligent Dramiński TG pro coffee moisture meter.

The manufacturer – DRAMIŃSKI S.A. serves the users with its knowledge and at the same time reserves the right to introduce changes and improvements in design and software. DRAMIŃSKI S.A. also reserves the right to amend the contents of the manual.

Read this manual carefully before starting the device. This will guarantee safe, long and reliable operation of the moisture meter.

The declaration of conformity of the device is available at the seat of DRAMIŃSKI S.A., ul. Owocowa 17, 10-860 Olsztyn, Poland.

For more information and always up-to-date data please visit **[www.draminski.com](http://www.draminski.com)**

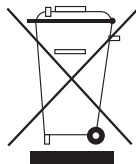

Please note that electronic equipment, batteries and accumulators must not be disposed of in standard household waste containers. It is the user's responsibility to dispose of this type of waste to appropriate disposal companies in accordance with the applicable laws and regulations. By ensuring proper disposal, you help to protect the environment.

# EQUIPMENT

## SECTION 1

EN

## EQUIPMENT:

1. Dramiński TG pro coffee moisture meter,
2. Measuring chamber clamping nut (with mounted 3V CR-2032 type battery),
3. Transport case,
4. Case strap for hanging,
5. USB cable for communication with a computer,
6. Instruction manual,
7. 4 x 1.5 V AA LR6 type alkaline battery,
8. Rubber cover for mini USB socket.



# DESIGN OF THE DEVICE

## SECTION **2**

EN



## DESIGN OF THE DEVICE

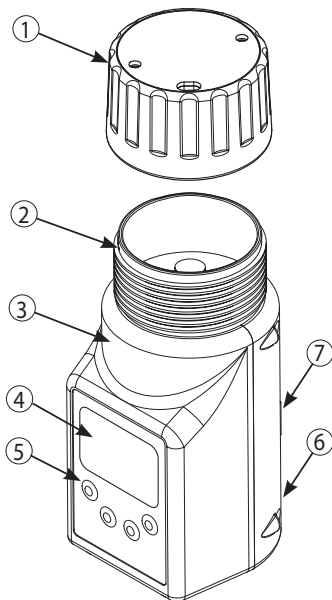

1. Clamping nut with a buzzer signalling appropriate clamping force,
2. Measuring chamber with a digital temperature sensor,
3. Housing made of high-quality ABS,
4. Graphic LCD display with LED backlighting,
5. Diaphragm keyboard with 4 keys,
6. Mini USB socket with rubber cover,
7. Compartment for four 1.5 V AA LR6 type batteries.

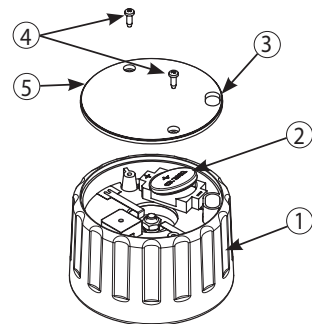

1. Nut housing made of polyamide with added glass fibre,
2. 3V battery (CR-2032 type) of the buzzer,
3. Opening for residual grain removal,
4. 2.5x10 screws,
5. Nut cover.

## APPROXIMATE DIMENSIONS

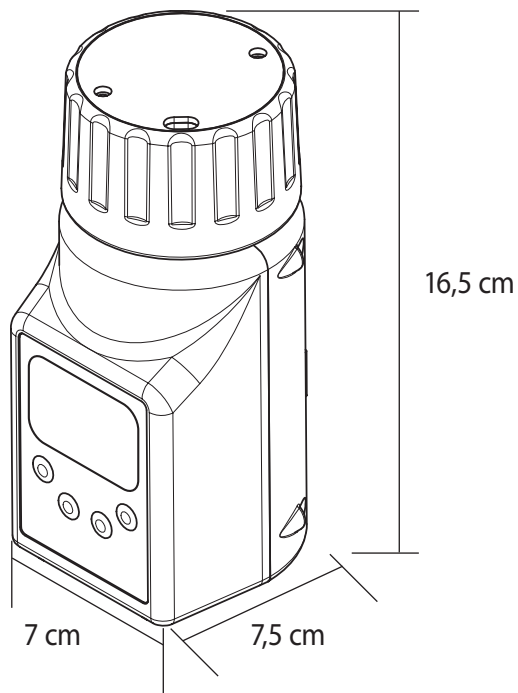







# KEYBOARD FUNCTIONS

## SECTION **3**

EN



	<ul style="list-style-type: none"> <li>- Turning on the device.</li> <li>- Turning off the device by holding down the key for 5 seconds (NOTE! TG pro coffee can also be turned off via the menu by using the <b>“Turn off!”</b> option, and if not in use, it will automatically turn off to save batteries).</li> <li>- Turning on the main menu by holding down the key for 2 seconds.</li> <li>- Cancelling program functions.</li> </ul>
	<ul style="list-style-type: none"> <li>- Approval of the program functions.</li> <li>- Start of the measurement.</li> </ul>
	<ul style="list-style-type: none"> <li>- Navigation through the menu.</li> <li>- Setting values in menu options.</li> <li>- Selection of the required species from the list.</li> </ul>
	<ul style="list-style-type: none"> <li>- Cleaning the average result during measurements of the moisture content of a given sample.</li> </ul>
	<ul style="list-style-type: none"> <li>- Saving the result with date and time to the memory of the device.</li> </ul>

# STARTING THE DEVICE

## SECTION 4

EN

TG pro coffee will be ready for use if the batteries are correctly inserted in the battery compartment (pay attention to polarity). The main menu of the device makes it possible to independently select the operating mode you want to use (basic or advanced). The basic mode is designed to ensure easy use and quick and convenient measurement of the moisture content and temperature of the sample to make the operation user-friendly even for beginners. The advanced mode includes options enabling the use of an external temperature probe, saving thousands of measurements to the internal memory of the device with date and time, classification of measurements into samples, storage area, suppliers and many others in order to satisfy the most demanding customers.

**Note!** If you use the advanced mode, you can download from our website at [www.draminski.com](http://www.draminski.com) a special software for communication with your computer, which allows you to download data from TG pro coffee to your computer, create reports, printouts, charts, spreadsheets etc.

Turn on the device with the  key.

a) a welcome message will appear on the display specifying the name of the device, software version, calibration version and serial number, e.g.



b) then a list of available species will be displayed, while the top of the display will show the model of the device and the current battery status (the date will also be visible in the advanced mode). When turned on, the device will backlight the last tested species, e.g.

**Basic mode**



**Advanced mode**



**NOTE:** If the battery is too low to continue operation, the device will automatically signal this with the following message:

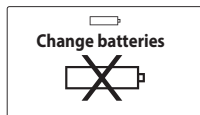

This means that the batteries must be replaced with new ones.

c) in order to save the power source when the keys are not in use, after some time the device will go into a standby mode, i.e. the backlight will go out (this time can be changed in the menu - see section: MAIN MENU). After pressing any key, the device will return to the working state,

d) if TG pro coffee remains in the standby mode for a few minutes, the power will be off automatically (this time can be changed in the menu - see section: MAIN MENU). The device will signal this by activating the backlight and the display will show a countdown from 10 to 0, which can be interrupted with any key; otherwise the device will turn itself off in order to save the source of power, e.g.



e) in order to turn off the device on your own, hold down the  key for 5 seconds or select the **"Turn off!"** option from the main menu,

f) during measurements, in the lower part of the display you can see hints as to what the key from the membrane keyboard is responsible for at a given moment, e.g.



In the advanced operating mode:



(**Esc** function) returns to the list of available species,



(**Clr** function) clears the average result,



(**Mem** function) saves the result to the internal memory,



(**Start** function) starts the next measurement.

# NOTES TO THE MEASUREMENTS

## SECTION **5**

EN

- Before starting the measurement, check whether the measuring chamber is clean and dry. Remember to remove the sample from the measuring chamber after the measurement has been completed.
- Fill the measuring chamber flush with its edge and then tighten the clamping nut until the buzzer is activated. It is forbidden to add the sample after compressing. In case of some species with increased moisture content, the nut may not sound and in this case it should be fully tightened to the end of the thread in order to take the measurement.
- If the signal from the clamping nut is weak, unscrew the nut cover and replace the battery with a new one. It is forbidden to bend the plates causing the buzzer to switch on.
- During the measurement the remains of the tested material may get into the thread of the nut. To make it easier to tighten the nut, clean the thread regularly without using sharp tools.
- When cleaning the chamber, remember to do it carefully so as not to damage the temperature sensor located at the bottom of the measuring chamber.
- Remember that the device features automatic temperature compensation therefore make sure that the temperature of the measuring chamber is close to the temperature of the tested sample (do not test the cooled sample in a device heated e.g. in the sun and vice versa).
- The final result should be taken as the average value e.g. from the last 3 measurements of a given sample (the average is calculated and displayed automatically). The number of measurements from which the average is calculated can be changed in the main menu.
- In order to be able to store moisture content measurements in the device's memory, activate the advanced operating mode (additionally, in the main menu of the device you can choose whether you want to store the result or the average from the measurements).

- In order to be able to store measurements from an external temperature probe in the device's memory, it is necessary to activate the advanced operating mode and give the probe its own name in the settings (this is necessary so that the results can be put in a directory in a proper way).
- In case of major deviations of the results of a given species consisting in overestimating or underestimating the results by a similar value within the whole measurement range in relation to the laboratory method (moisture balance), a result modification should be applied (see section: MODIFICATION OF HUMIDITY RESULTS).
- Each species has a different range of measured moisture content, while exceeding it is indicated by a corresponding sign, e.g.
  - "<8.5%" (below the range) when the moisture content of the tested sample is lower than 8.5%,
  - ">35.0%" (above the range) when the moisture content of the tested sample is higher than 35%.







# HUMIDITY MEASUREMENTS

## SECTION 6

EN

### To measure humidity:

- a) turn the device on with the  key, after a short welcome message a list of available species will appear (when turned on, TG pro coffee highlights the name of the most recently tested species),
- b) use the  or  keys to select (highlight) the name of the species you will be testing at the moment and then confirm with the  key,



- c) as indicated on the display, fill the measuring chamber with the tested sample (flush with edges),
- d) screw the clamping nut onto the measuring chamber's thread until you hear the buzzer emitting a beep sound coming from the nut. This means the correct compression force, but to save the battery of the buzzer, unscrew the nut as little as possible until the signal disappears.

- e) when the sample is correctly compressed, start the measurement ("Start" function) by pressing the  key (**NOTE** when the display shows the following message "Analysing...", do not touch the measuring chamber),

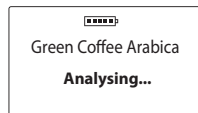

- f) after a few seconds, the display shows the result of the moisture content as a percentage (%) value and the temperature of the sample (in °C or °F depending on the user's settings),

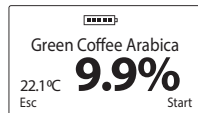

- The result of the humidity measurement is given considering the correction related to the sample temperature (automatic temperature compensation),

g) after the measurement is complete, unscrew the clamping nut and empty the measuring chamber taking care not to mechanically damage the temperature sensor at the bottom. If necessary, clean the clamping nut thread. After cleaning the measuring chamber, the device is ready for further work. To measure another sample of the same species, fill the measuring chamber and tighten the nut correctly, then start the measurement with the **OK** key (or use the **ESC** key to return to the list to select another species).

**NOTE:** Particularly thorough cleaning of the measuring chamber is required when changing the species of grain to be measured and when measuring samples with very different and increased moisture content,

h) the final result of the moisture content of a given sample should be the average of e.g. the last 3 measurements. TG pro coffee calculates it automatically and displays it on the left side of the display (above the temperature result) e.g.

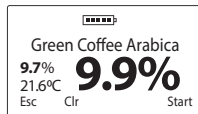

The number of measurements from which the average is calculated can be changed in the main menu. Results above and below the limit are not considered when calculating the average moisture content. In order for the average result to be counted from the beginning we can clear it (**Clr** function) by pressing the **DOWN** key or by going back to the species list by pressing the **ESC** key,

i) Dрамиński TG pro coffee allows you to save 50 thousand measurements to the internal memory using the **UP** key (**Mem** function). In order to use this function, change the operating mode in the main menu to "advanced". Additionally, in the device settings, the user can choose whether the current result or the average of the last measurements is to be saved,





- j) after completing the measurements, in order to save the power source, turn off the device by holding down the  key for 5 seconds or using the **“Turn off!”** option available in the main menu.

# MEASUREMENTS WITH AN EXTERNAL TEMPERATURE PROBE

## SECTION **7**

EN

The Dramiński TG pro coffee moisture meter can also work as a professional thermometer when an external temperature probe is connected to the mini USB socket. The moisture meter is designed to allow users to purchase probes of different designs without the necessity to calibrate the probe with the device. Very importantly, each probe has its own unique ID number, thanks to which we can assign it its own name to take advantage of the possibility to store thousands of measurements with date and time in the device's built-in memory. TG pro coffee automatically recognizes the probes we connect and puts the stored results in a directory accordingly. The device menu makes it possible to conveniently manage your probes and device parameters (adding new probes, changing the name, deleting from the memory, cleaning the results from the device's memory, changing the temperature scale °C/°F), therefore to learn all the functions we recommend reading section 11: MAIN MENU. MAIN MENU.

1. To use the temperature probe, turn on the advanced operating mode, then connect the external probe to the mini USB socket and activate the "Temperature measurement" option in the main menu. Probes which are not yet added to the memory under their own name are recognized by the device as "No name".

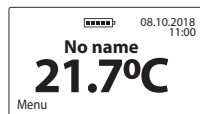

2. In order to use the possibility of saving the results, it is necessary to add the probe to the device's memory (see section 11: MAIN MENU). When the probe is stored, the device will automatically recognize it and display the name assigned to it, e.g. "PROBE NO 1". At this point by means of the  key (**Mem** function) we can save thousands of results with date and time in the memory to transfer them to the computer and store, create reports, spreadsheets, charts of changes in the time function or generate printouts.

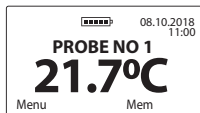

Special software for data transmission is available at [www.draminski.com](http://www.draminski.com) under **Products / Moisture meters / Dрамиński TG pro coffee.**



# LIST OF AVAILABLE SPECIES AND ADDING NEW SPECIES

## SECTION 8

EN

The Dramiński TG pro coffee moisture meter is able to store even several hundred different species and their varieties in the internal memory, which can be used during measurements.

An up-to-date list of all available species is available at **www.draminski.com** under **Products / Moisture meters / Dramiński TG pro coffee**.

Every user of the Dramiński TG pro coffee moisture meter can activate an additional species by entering a special code in the main menu through the **“Add species”** option (see section: MAIN MENU). In order to get a special code activating the species you need in your device, please contact us via:

**e-mail: [agri@draminski.com](mailto:agri@draminski.com)**

**phone: +48 89 527 11 30**

or with a local authorized certified distributor of Dramiński S.A.

Contact us also if you have a species that we have not yet developed or a special variety of seeds that you would like to test because together we can remotely create a special species for your needs, in case of which it will also be possible to activate the same via a code in your device.

# UPDATE VIA USB

## SECTION 9

EN



The Dramiński TG pro coffee moisture meter is equipped with a mini USB socket so you can quickly and conveniently update your device's memory, software, list of available language versions, activate new functions on your device and many more.

Check the availability of new updates at **www.draminski.com** under **Products / Moisture meters / Dramiński TG pro coffee**.

Our programmers spared no effort to make the update extremely easy to implement so that even users with minimum computer literacy can easily cope with it.

Should you have any questions or concerns, please do not hesitate to contact our specialists.

**e-mail: [agri@draminski.com](mailto:agri@draminski.com)**

**phone: +48 89 527 11 30**

# MODIFICATION OF HUMIDITY RESULTS

## SECTION 10

EN

The Dramiński TG pro coffee moisture meter has moisture curves for each species stored in the memory which have been developed on the basis of standardized samples so that the results are accurate and repeatable. However, it may be the case that in a given year (due to various factors) the user's harvest is slightly different from the standardized seeds and then deviations may occur in the moisture content results.

Such factors include:

1. seed development and ripeness (robustness),
2. varietal characteristics,
3. degree of pollution and tailings.

#### NOTE:

Remember to compare the results of measurements only to the laboratory method, moisture balance and not to other moisture meters because they may be misleading.

The Dramiński TG pro coffee moisture meter allows you to modify (correct) the readings yourself.

When making modifications, each species is treated separately. After the modification, an asterisk "\*" appears next to the name of the species and during measurements above the name of the tested species the information will be displayed on the value by which we modified the results (the result automatically takes into account the introduced modification), e.g.

before

after

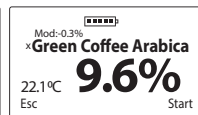

It is recommended to restore the factory data in the next year and if necessary, make a new correction of results (modification). When we restore the factory settings, the asterisk "\*" next to the name of the species also disappears.

**A detailed description of how to modify the humidity results and how to restore the factory settings can be found in the section: MAIN MENU.**



# MAIN MENU





## SECTION 11

EN

Thanks to the functions contained in the main menu of the device, the user can quickly turn off the device, adjust operational settings to their needs, add new species, manage memory and many more.

**To turn on the MAIN MENU, hold down the  key for about 2 seconds.**



### 1. Turn off!

To turn off the device, go to the **Main menu** using the  key, then use the  or  key to select the **Turn off!** option and confirm with the  key.



Thanks to this function, the user can quickly and conveniently turn off the device without the necessity to hold down the  key for 5 seconds and wait for the power auto off option.

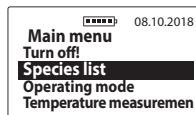

### 2. Species list

To return to the species list from the **Main menu**, use the  key or use the arrows to select the **Species list** option and confirm with the  key.

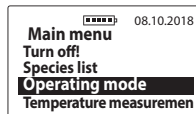

### 3. Operating mode



a) **Basic** – in order to facilitate the operation of the device and to use only the basic menu functions, go to the **Main menu / Operating mode**, then using the  or  key select the **Basic** option and confirm with the  key, e.g.

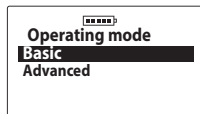

- b) **Advanced** – in order to enable all the options of the device such as real time clock, saving measurements, temperature probe operation, etc. go to the **Main menu / Operating mode**, then using the  $\downarrow$  or  $\uparrow$  key select the **Advanced** option and confirm with the  $\text{OK}$  key, e.g.

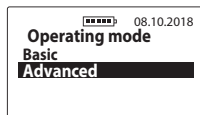

#### 4. Temperature measurement

To use an external temperature probe, connect it to TG pro coffee via the mini USB socket, go to the **Main menu**, then using the  $\downarrow$  or  $\uparrow$  key select the **Temperature measurement** option and confirm with the  $\text{OK}$  key.

**NOTE** To use the option of saving the results to the device's memory, add the probe in the main menu settings and assign any name to it.

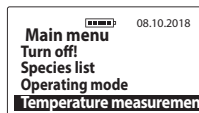

#### 5. Settings



##### 5.1 Language



To change the language version of the device, go to the **Main menu / Settings / Language**, then select the language version using the  $\downarrow$  or  $\uparrow$  key and confirm with the  $\text{OK}$  key, e.g.

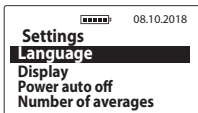



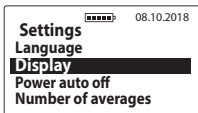



## 5.2 Display

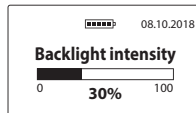

- 5.2 a) **Backlight intensity** – we used energy-saving LED backlighting but remember that stronger backlighting is associated with increased power consumption, which leads to a faster discharge of the battery. To change the backlight intensity, go to the **Main menu / Settings / Display / Backlight intensity**, then select the appropriate value using the  or  key and confirm with the  key, e.g.



- 5.2 b) **Backlight off time** – adjustment of the time after which the backlight of the display is off and the device goes into the idle state waiting for the keyboard to be used again (the time is counted from the last click/use of the key on the keyboard of the device). To change the backlight off time, go to the **Main menu / Settings / Display / Backlight off time**, then select the appropriate value using the  or  key and confirm with the  key, e.g.

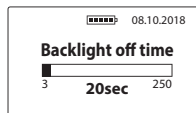

5.2 c) **LCD contrast** – to change the contrast of the display, go to the **Main menu / Settings / Display / LCD contrast**, then select the appropriate value using the (v) or (^) key and confirm with the (OK) key, e.g.

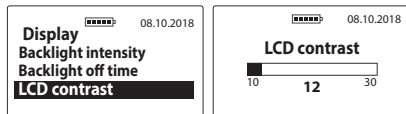

### 5.3 Power auto off

Adjustment of the time after which the device turns off automatically counting from the last click/use of the keyboard. To change the power automatic off time, go to the **Main menu / Settings / Power auto off**, then select the appropriate value using the (v) or (^) key and confirm with the (OK) key, e.g.

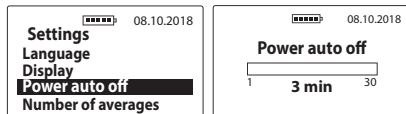





### 5.4 Number of averages

The device automatically calculates the average of the last measurements. To set how many measurements are to be counted as an average, go to the **Main menu / Settings / Number of averages**, then select the appropriate number using the (v) or (^) key and confirm with the (OK) key, e.g.

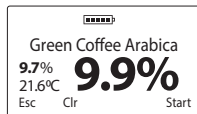



the average result will appear on the left side of the display (above the temperature) after the third measurement if the number of averages is set to "3", e.g.



**NOTE:** In order for the average result to be counted from the beginning we can clear it (**Clr** function) using the  key, which will activate the “Reset average?” message. Then we can confirm with the  key or cancel it with the  key (the average will also be deleted if we return to the list and choose the species again).

### 5.5 Temperature scale



To change the temperature scale from Celsius degrees to Fahrenheit degrees or vice versa, go to the **Main menu / Settings / Temperature scale**, then select the appropriate scale using the  or  key and confirm with the  key, e.g.



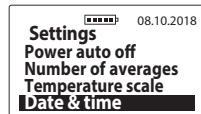

### 5.6 Date & time

TG pro coffee has a real time clock so that the measurement results are stored together with the actual date and time of performance.

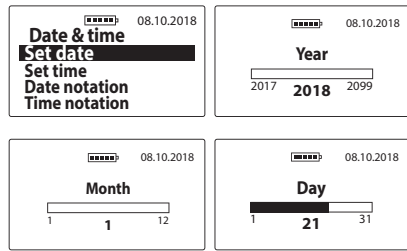

5.6 a) **Set date** – to set the current date, go to the **Main menu / Settings / Date & time / Set date**, then use the  or  key to select the appropriate value and press the  key to confirm the year/month/day, e.g.



5.6 b) **Set time** – to set the current time, go to the **Main menu / Settings / Date & time / Set time**, then use the  or  key to select the appropriate value

and press the **OK** key to confirm the hour/minutes, e.g.

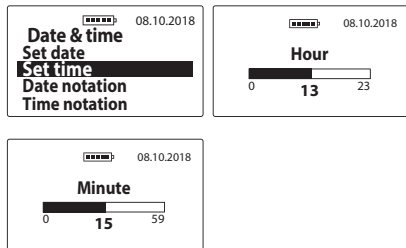

5.6 c) **Date notation** – to change the format of date display, go to the **Main menu / Settings / Date & time / Date notation**, then use the **↓** or **↑** key to select the appropriate option and confirm with the **OK** key, e.g.

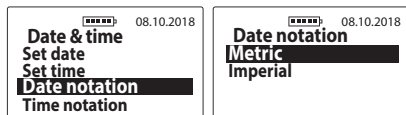

5.6 d) **Time notation** – to change the format of date display, go to the **Main menu / Settings / Date & time / Time notation**, then use the **↓** or **↑** key to select the appropriate option and confirm with the **OK** key, e.g.



## 5.7 Temp. probe

This option allows you to add external temperature probes to the memory in order to save their measurements to the appropriate directory, rename previously saved probes or delete them completely with their measurement directory.

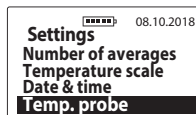

5.7 a) **Add probe** – to add a probe and create a measurement directory, connect it into the mini USB socket, go to the **Main menu / Settings / Temp. probe / Add probe**, enter your own name for the probe (use the arrows to change and the **OK** key to confirm the highlighted characters); when the name is ready, use the **ESC** key, then the “**Save the name?**” message will appear which should be accepted with the **OK** key or cancelled with the **ESC** key, e.g.

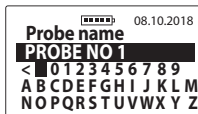
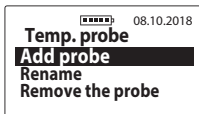

5.7 b) **Rename** – to change the name of the previously saved probe, go to the **Main menu / Settings / Temp. probe / Rename**, select the name you want to change with the arrows and accept it with the **OK** key, enter a new name for the probe (use the arrows to change and the **OK** key to confirm the highlighted characters); when the name is ready, use the

**ESC** key, then the “**Save the name?**” message will appear which should be accepted with the **OK** key or cancelled with the **ESC** key, e.g.

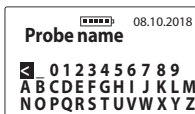
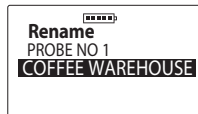
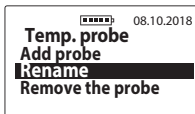

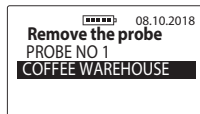

5.7 c) **Remove the probe** – to remove a given probe together with its measurements, go to the **Main menu / Settings / Temperature probe / Remove the probe**, select with the arrows the name of the probe you want to remove and confirm with the **OK** key, then the “**Delete?**” message will appear, which should be accepted with the **OK** key or cancelled with the **ESC** key.



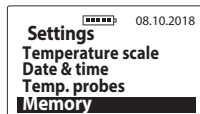

## 5.8 Memory



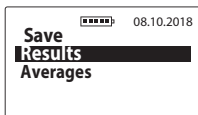

5.8 a) **Save** – to change the way of saving the measurements, go to the **Main menu / Settings / Memory / Save**, then use the  or  key to select the appropriate option and confirm with the  key, e.g.





5.8 b) **Delete humidity results** – to delete all stored humidity results, go to the **Main menu / Settings / Memory**, then use the  or  key to select the **Delete humidity results** option and confirm with the  key.



5.8 c) **Delete temperature results** – to delete all stored temperature results from the external probes, go to the **Main menu / Settings / Memory**, then use the  or  key to select the **Delete temperature results** option and confirm with the  key.



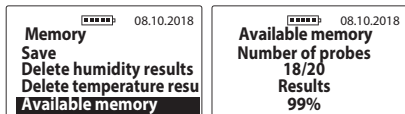

5.8 d) **Available memory** – to check the current amount of free space in the device's memory, go to the **Main menu / Settings / Memory**, use the  or  key to select the **Available memory** option and confirm with the  key, e.g.



## 6. Result modification

**Before modifying (correcting) the results, read the MODIFICATION OF HUMIDITY RESULTS.**

To modify a given species, go to the **Main menu / Result modification**, use the  or  key to select the species name which you want to modify, then set the value by which you want to increase or decrease the humidity results and confirm the choice with the  key, e.g.

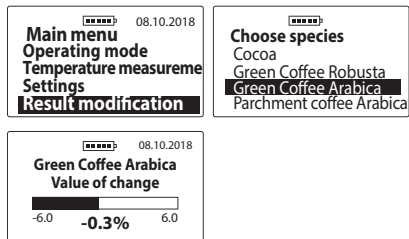

After the modification, an asterisk "\*" appears next to the name of the species indicating that the factory settings have been changed, and during measurements above the name of the tested species the information will be displayed on the value by which we modified the result, e.g.

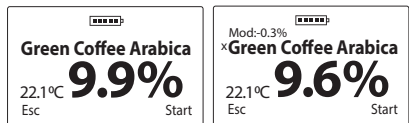

To restore the factory settings, set the value of the correction to **"0.0%"**, then the asterisk next to the name of the species will disappear, e.g.

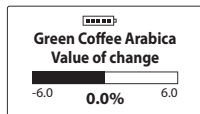

## 7. Add species

First, please refer to the following section: LIST OF AVAILABLE SPECIES AND ADDING NEW SPECIES.

To add a new species in the TG pro coffee moisture meter, go to the **Main menu** using the key, then use the or key to select the **Add species** option and confirm with the key, e.g.

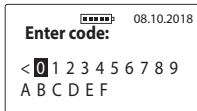
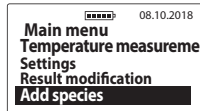

To enter a special code, select the appropriate characters with the or key and confirm with the key (to delete the character, select the "<" symbol and confirm with the key).

When you enter the whole code, the **"Accept code?"** message appears which must be confirmed with the key, e.g.

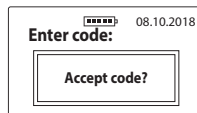

**NOTE:** By entering the same code, the species are added and removed (alternately) in the available device list. The codes are matched to the device, so if, for example, you want to activate a new species in two TG pro coffee moisture meters, you will need two different codes.

## 8. About

To check the device information and manufacturer's contact details, go to the **Main menu** using the key, then use the or key to select the **About** option and confirm with the key.



Here we can conveniently check e.g. device model, software version, serial number of the device as well as the address and contact details of Dramiński S.A. on page 2.



# BATTERY REPLACEMENT

## SECTION 12

EN

The device features an automatic indication that the battery is discharged. In this case, the **“Change battery”** message in the form of a graphic symbol will be displayed immediately after turning on or during use and TG pro coffee will automatically turn off.

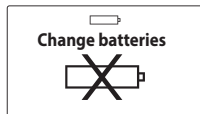

The moisture meter is powered by four 1.5V AA LR6 type batteries.

### To replace the batteries:

- Remove the battery compartment cover at the back of the case and remove the used batteries using the ribbon,
- Place the ribbon crosswise inside the battery compartment so that the end of the ribbon protrudes,
- Insert a new battery set according to the +/- polarity markings (pressing the ribbon inwards),
- Replace the battery compartment cover.

When a clear click is heard it means that the protection in the cover is properly fastened and there is no risk of the battery slipping out

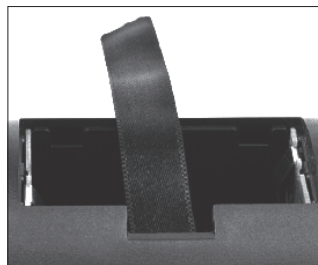

### **Battery replacement in the clamping nut with a buzzer.**

One 3V battery (CR-2032 type) powers the sounder (buzzer) in the clamping nut of the measuring chamber. When the sound disappears or is visibly weaker, replace the battery with a new one.

To replace the battery:

- Unscrew the two screws in the nut cover,
- Lift the cover and gently lift the battery out of the base by lifting it,
- Insert a new battery according to the +/- polarity markings,
- Replace the clamping nut cover and screw in the two screws (2.5x10) that secure it.

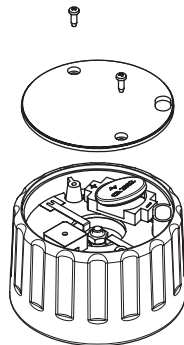



# FINAL REMARKS

## SECTION 13

EN

- Protect the moisture meter from direct contact with water. Also, avoid using it alternately at extreme temperatures. Do not allow the condensation of water vapor from the air on metal parts of the device as this may affect the measurement results.
- After the end of the season, carefully clean and dry the measuring chamber and the clamping nut. Store the device in a dry and warm room. Due care in case of maintenance and proper storage conditions guarantees long-term and trouble-free operation.
- If the device is not going to be used for a longer period of time, we recommend that you remove the batteries from the battery compartment of the device to reduce the risk of damage resulting from electrolyte leakage.  
**We recommend the use of batteries from reputable manufacturers.**
- In case of problems with the device or difficulties in interpreting the results, we recommend (before sending the device for service) contacting the manufacturer, i.e. DRAMIŃSKI S.A. or a local authorized and certified distributor. The contact with the above-mentioned entities is advisable especially before sending the device for warranty service because most of the problems can be solved remotely, while unjustified sending an efficient and operating device can entail the costs of inspection and shipping.
- It is forbidden to disassemble the device, interfere with it in any way or to have it serviced by unauthorized persons, as this may cause permanent damage and will affect the warranty conditions.
- Pay attention to the rubber cover of the mini USB socket because if it is not in place, the socket is exposed to significant dirt.

# TECHNICAL DATA

## SECTION **14**

EN



<b>Dimensions</b>	16.5 × 7.0 × 7.5 cm
<b>Unit weight</b>	520 g (with a set of batteries and nut)
<b>Sample loading</b>	manual
<b>Moisture measurement method</b>	impedance, at 4 frequencies
<b>Sample volume</b>	90 ml
<b>Measurement control</b>	Single chip microcomputer
<b>Power supply</b>	4 batteries type AA, 1.5 V, 1 battery type CR2032, 3V
<b>Power consumption</b>	from 30 to 72 mA depending on user's settings
<b>Estimated life of battery set</b>	77 hours at 0% backlighting 54 hours at 30% backlighting
<b>Battery low indication</b>	graphic
<b>Measurement resolution</b>	moisture content – 0.1%, temperature – 0.1°C/°F
<b>Accuracy of moisture content measurement</b>	± 0.5% for standardized grain ± 1% in the range up to 10 % of moisture content ± 1.5% in the range above 10 % of moisture content and can increase with the increase content with the increase of sample's moisture content
<b>Accuracy of temperature measurement</b>	± 0.5°C in the range of 0°C to 85°C / ± 0.9°F in the range of 32°F to 185°F
<b>Range of temperature measurement</b>	from 0 °C to 125 °C
<b>Result modification</b>	using keyboard – modification option
<b>Data recording</b>	internal memory
<b>Internal memory capacity</b>	– 50,000 measurements with date and time – 20 external temperature probes automatically recognized by ID number – 20 language versions – 400 species

<b>Checking memory status</b>	from menu
<b>External temperature probe</b>	with digital temperature sensor, connected via mini USB socket
<b>Display</b>	graphic LCD with LED backlight, diagonal 2"
<b>Keyboard</b>	membrane
<b>Temperature compensation</b>	automatic
<b>Additional functions</b>	<ul style="list-style-type: none"> <li>real time clock,</li> <li>recording of measurement results to the memory (with date, time and sample number),</li> <li>data transmission to a computer,</li> <li>memory status preview,</li> <li>battery status preview,</li> <li>temperature measurement with an external probe,</li> <li>change of operating mode (basic/advanced),</li> <li>modification of humidity results,</li> <li>adding new species through special codes,</li> <li>calculation of the average result,</li> <li>automatic temperature compensation,</li> <li>pop-up menu,</li> <li>setting the display operating parameters,</li> <li>selection of language version,</li> <li>selection of temperature scale,</li> <li>change of automatic shutdown time (power auto off),</li> <li>data and software update,</li> <li>special software for managing data stored on the computer (generation of reports, spreadsheets, charts, printouts)</li> </ul>
<b>Recommended working temperature</b>	from 10 °C to 35 °C
<b>Recommended storage temperature</b>	from 5 °C to 45 °C



[www.draminski.com](http://www.draminski.com)



**DRAMIŃSKI S.A.**

Owocowa 17, 10-860 Olsztyn, Poland

phone: +48 89 527 11 30

e-mail: [wilgo@draminski.com](mailto:wilgo@draminski.com)

instr.TGproC0119EN1.1